



USB C 3.1 Rev. Plug Clamp Type Series



UBPO31-24SG-TXX
 T10: Board Thickness 1.0mm (0.8/1.6mm)
 No. of Contacts (24pin)
 Plug Solder Type

USB C 3.1 Rev. Plug Straight SMT Type Series



UBPV31-24SGXX
 5: Selective Gold 5u"
 15: Selective Gold 15u"
 30: Selective Gold 30u"
 No. of Contacts (24pin)
 Plug Straight Type

USB C 3.1 Rev. Socket H3.45mm SMT+Dip Type Series



UBSR31H1-24SG-XX
 5: Selective Gold 5u"
 15: Selective Gold 15u"
 30: Selective Gold 30u"
 No. of Contacts (24pin)
 Socket R/A Type

USB C 3.1 Rev. Socket H1.9mm SMT+Dip Type Series



UBSR31-24SG-XX
 5: Selective Gold 5u"
 15: Selective Gold 15u"
 30: Selective Gold 30u"
 No. of Contacts (24pin)
 Socket R/A Type

USB C 3.1 Rev. Plug Sloder Board Series



UBPOB31-24-XX
 30: USB 3.0 Rve. Type
 20: USB 2.0 Rve. Type
 No. of Contacts (24pin)
 Plug Straight Type

USB C 3.1 Rev. Socket Waterproof SMT+Dip Type Series



UBSR31IPA-24SG-BK
 No. of Contacts (24pin)
 Waterproof
 Socket R/A Type

Mirco USB AB Waterproof SMT Type Series



MUABPRSM-05IP
 Waterproof
 No. of Contacts (5pin)
 Plug SMT R/AAB Type

PCB Jack +USB Socket Double R/A Type Series



RJDRMUBS-8P8C-LYRG
 Left LED Yellow
 Right LED Green
 No. of Contacts (8/10pin)
 USB Socket
 PCB JACK With Shielded

Mirco USB Waterproof SMT Type Series



MUBPRSM2-05IP
 Waterproof
 No. of Contacts (5pin)
 Plug SMT R/A Type

USB 3.0 Rev. A Socket Double Row Solder Series



UBSAO-18-XX
 BU: Blue
 BK: Black
 No. of Contacts (18pin)
 Socket Solder Type

Mirco USB Waterproof SMT Type Series



MUBPRSM1-05IP
 Waterproof
 No. of Contacts (5pin)
 Plug SMT R/A Type

1.00mm FPC/FFC Connector NON ZIF SMD Vertical Double



FPCVSM10-XX
 No. Of Contacts (3 To 30 Ways)
 1.0mm Vertical
 V: Straight Type
 VSM: Vertical

1.00mm FPC/FFC Connector NON ZIF Dip Double Contacts

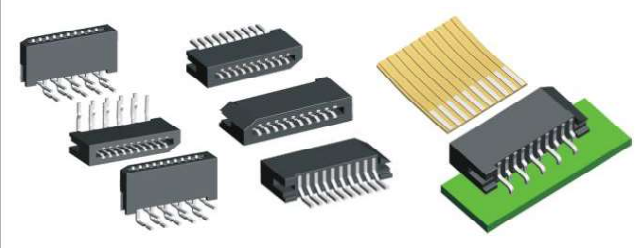

FPCRSM10-XX
 No. Of Contacts (3 To 30 Ways)
 1.0mm Horizontal
 R/R/A Type
 RSM: R/A SMT Type

0.50mm FPC/FFC SMD Side Entry Top & Bottom Contact

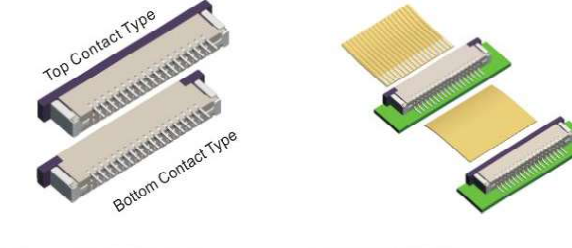

FPCRSM05-XX-XX
 BC: Bottom Contact Type
 TC: Top Contact Type
 No. Of Contacts (4 To 50 Ways)
 0.5mm R/A SMD Type

1.00mm FPC/FFC Connector NON ZIF Dip Single Contact

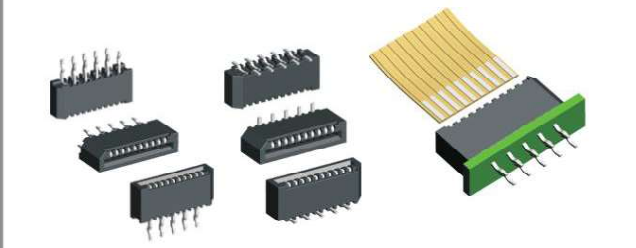

FPCVSM110-XX
 No. Of Contacts (3 To 30 Ways)
 V: Straight Type
 VSM: Vertical

1.00mm FPC/FFC SMD Side Entry Top & Bottom Contact

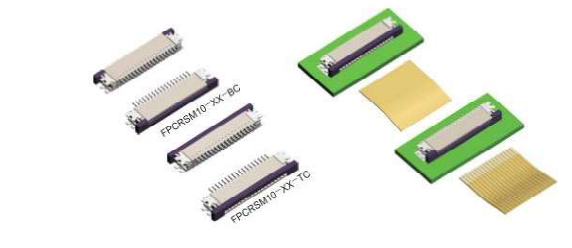

FPCRSM10-XX-XX
 BC: Bottom Contact Type
 TC: Top Contact Type
 No. Of Contacts (3 To 32 Ways)
 R/A SMD Type

2.54mm FPC/FFC Connector NON ZIF Double Contacts

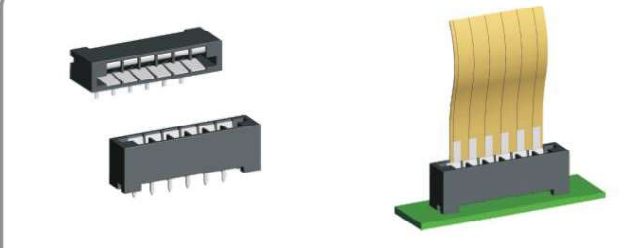

FPCV254-XX
 No. Of Contacts (3 To 30 Ways)
 V: 2.54mm Straight Type
 R: 2.54mm Right Angle Type